

Republic Supplies

CONTRACTOR SPECIALTY SUPPLIES

CATALOG

EDITION 4

Roller Covers

Floor Discs

Gloves

Tools

Dust Collection

Handles

Rags

Batch Mixers

Vacuums

Squeegees

Floor Scrapers

Cup Wheels

Floor Sweeps

Safety Products

Grinders

Scarifiers



Quick Index

APPLICATION TOOLS	9
APPLICATOR PADS & BLOCKS	4
BARRICADE TAPE	6
BATCH MIXERS	11
CHIP BRUSHES	4
DIAMOND TOOLS	6
DUST COLLECTION	10
EQUIPMENT	11
EXTENSION CORDS	6
FANS	6
FLOOR MACHINES	9
FLOOR MAGNETS	7
FLOOR SANDING PRODUCTS	8
FLOOR SQUEEGEES	3
FLOOR SWEEPS	4
FLOOR TOOLS	7
GAUGE RAKES	8
GLOVES	5
HANDLES	2
KNEE PADS	5
MINI ROLLER COVERS AND FRAMES	1
MIXERS	12
PAILS	4
PLASTIC TERMINATION STRIPS	8
PORCUPINE ROLLER COVERS	9
PORTABLE LIGHTING	6
POWER TROWELS	11
PROFESSIONAL ROLLER FRAMES	2
RAGS	2
ROLLER COVERS	1
SAFETY	12
SCREED BOXES/TOTER	11
SPIKED ROLLERS	9
SPIKED SANDALS	8
TAPE	5
VAPOR TESTING	8



2229 Pembroke Place, Denton, TX 76205

Phone: 800.713.7157 Fax: 940.484.5287

email: kp@republicsupplies.net

www.republicsupplies.net

ROLLER COVERS

FAX: 940-484-5287

Roller Covers

18RC25	18" Roller Cover, 1/4" Nap	24/ctn
18RC38	18" Roller Cover, 3/8" Nap	24/ctn
18RC50	18" Roller Cover, 1/2" Nap	24/ctn
18RC75	18" Roller Cover, 3/4" Nap	24/ctn
18RC125	18" Roller Cover, 1-1/4" Nap	24/ctn
9RC25	9" Roller Cover, 1/4" Nap	36/ctn
9RC38	9" Roller Cover, 3/8" Nap	36/ctn
9RC50	9" Roller Cover, 1/2" Nap	36/ctn
9RC75	9" Roller Cover, 3/4" Nap	36/ctn
9RC125	9" Roller Cover, 1-1/4" Nap	12/ctn
4RC38	4" Roller Cover, 3/8" Nap	48/ctn
4RC50	4" Roller Cover, 1/2" Nap	48/ctn
4RC75	4" Roller Cover, 3/4" Nap	48/ctn
3RC38	3" Roller Cover, 3/8" Nap	48/ctn

Mohair Roller Covers

18MH25	18" Roller Cover, Mohair	24/ctn
9MH25	9" Roller Cover, Mohair	24/ctn

Looped Roller Covers

18-Loop	18" looped nap roller cover	12/ctn
9-Loop	9" looped nap roller cover	12/ctn

Carpet Nap Roller Covers

18-CNAP	18" Carpet Nap Roller Cover	12/ctn
9-CNAP	9" Carpet Nap Roller Cover	12/ctn
4-CNAP	4" Carpet Nap Roller Cover	36/ctn

Shed-Resistant Roller Covers

18SR25	18" shed resistant roller cover, 1/4" nap	24/ctn
18SR38	18" shed resistant roller cover, 3/8" nap	24/ctn
18SR50	18" shed resistant roller cover, 1/2" nap	24/ctn
18SR75	18" shed resistant roller cover, 3/4" nap	24/ctn
9SR25	9" shed resistant roller cover, 1/4" nap	36/ctn
9SR38	9" shed resistant roller cover, 3/8" nap	36/ctn
9SR50	9" shed resistant roller cover, 1/2" nap	36/ctn
9SR75	9" shed resistant roller cover, 3/4" nap	36/ctn
4SR25	4" shed resistant roller cover, 1/4" nap	48/ctn
4SR38	4" shed resistant roller cover, 3/8" nap	48/ctn
4SR50	4" shed resistant roller cover, 1/2" nap	48/ctn
4SR75	4" shed resistant roller cover, 3/4" nap	48/ctn
3SR25	3" shed resistant roller cover, 1/4" nap	48/ctn
3SR38	3" shed resistant roller cover, 3/8" nap	48/ctn
3SR50	3" shed resistant roller cover, 1/2" nap	48/ctn

MINI ROLLER COVERS & FRAMES

M6-SR25	6-1/2" x 1/4" nap, shed resistant cover	12/ctn
M6-SR80	6-1/2" x 3/8" nap, shed resistant cover	12/ctn
M6-SR50	6-1/2" x 1/2" nap, shed resistant cover	12/ctn
M4-SR38	4" x 3/8" nap, shed resistant cover	12/ctn
M4-SR50	4" x 1/2" nap, shed resistant cover	12/ctn
M4-RC38	4" x 3/8" nap roller cover	12/ctn
M4-RC50	4" x 1/2" nap roller cover	12/ctn
MRF6-1/2-24	24" frame for 6-1/2" cover	24/ctn
MRF6-1/2-14	14" frame for 6-1/2" cover	24/ctn
MRF6-1/2-11	11" frame for 6-1/2" cover	24/ctn
MRF4-16	16" frame for 4" cover	24/ctn

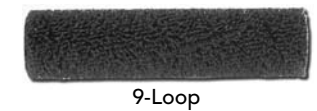
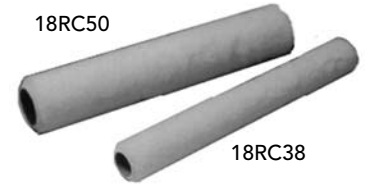

Carpet Nap Roller Covers



Shed-Resistant Roller Covers



Mini Roller Frames & Covers

Products Guaranteed To Your Satisfaction!

PROFESSIONAL ROLLER FRAMES

RF18HD	18" steel, 5 wire cage	.1 ea
RF18HD-CAGE	18" replacement cage	.1 ea
RF18LW-A	18" lightweight roller frame, aluminum	.1 ea
RF18LW-BP	18" lightweight roller frame, black plastic	.1 ea
RF18LW-9/18	18" yoke frame, adjustable, fits 9" thru 18"	.1 ea
RF18LW-R	18" lightweight roller frame, rigid yoke	.1 ea
RF18LW-ARF	18" lightweight adjustable roller frame	.1 ea
RF9HD	9" heavy duty frame, 5/16" rod, heavy-duty	.24/ctn
HD-1695	9" heavy duty frame, 5/16" rod, professional quality	.12/ctn
RF4	4" regular duty frame	.24/ctn
RF3	3" regular duty frame	.24/ctn
EC-R	end caps, 1/2" pin hole	.1 ea
EC-30	end caps, 1/4" pin hole	.1 ea
EC-18	end caps, 1/2" pin hole, rounded	.1 ea

HANDLES

Cast Metal Threaded

H60MT	15/16" x 60" metal threaded	.12/ctn
H72MT	15/16" x 72" metal threaded	.12/ctn
HD60MT	1-1/8" x 60" metal threaded	.12/ctn

Tapered End

H60T	15/16" x 60" tapered end	.12/ctn
HD54T	1-1/8 x 54" tapered end	.12/ctn
HD60T	1-1/8" x 60" tapered end	.12/ctn
HD72T	1-1/8" x 72" tapered end	.12/ctn

Special Handles

H60FG	15/16" x 60" fiberglass	.12/ctn
-------	-------------------------	---------

Extension Handles - Heavy Duty

H24AG	2' to 4', extension handle, fiberglass/aluminum	.6/ctn
H48AG	4' to 8', extension handle, fiberglass/aluminum	.6/ctn
H612AG	6' to 12', extension handle, fiberglass/aluminum	.6/ctn
H816AG	8' to 16' extension handle, fiberglass/aluminum	.6/ctn

Handle Braces

HB-M106	steel handle brace	.12/ctn
HB-M102	u-bolt style handle brace	.1 ea

RAGS

W114	white knit-reclaimed, 10lb or 25lb	.lb
W300	new colored knit, 10lb or 25lb	.lb
W140	white cotton fleece (sweatshirt), 10lb or 25lb	.lb
W124	colored cotton fleece (sweatshirt), 10lb or 25lb	.lb
W120	turkish terry, terry on two sides, 10lb or 25lb, white	.lb
W121	turkish terry, terry on two sides, 10lb or 25lb, colored	.lb
W123	special terry, terry on one side, 10lb or 25lb, colored	.lb
W110	colored flannel, 10lb or 25lb	.lb

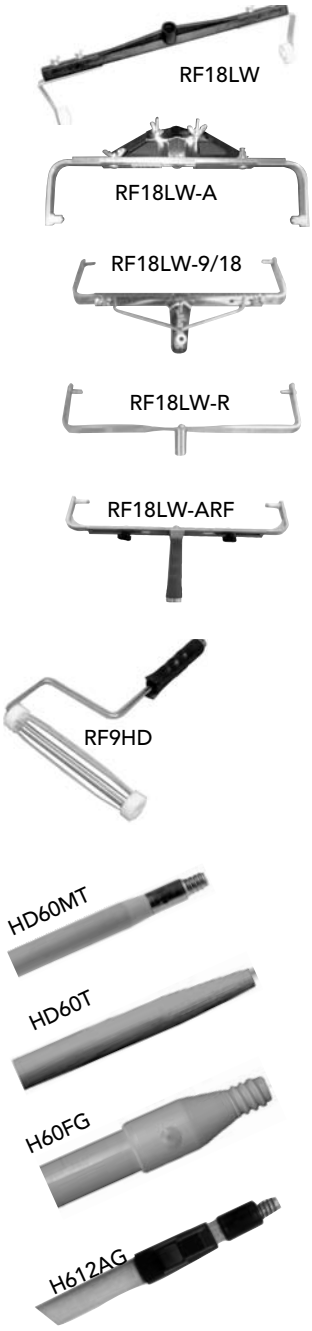

Colored Cotton Rags W124



White Cotton Rags W140

FLOOR SQUEEGEES

FAX: 940-484-5287

SD12-H	12" flat squeegee, H-line red, double blade	.12/ctn
SD16-H	16" flat squeegee, H-line red, double blade	.12/ctn
SD18-H	18" flat squeegee, H-line red, double blade	.12/ctn
WSQ12	12" window squeegee, red, economical	.12/ctn
WSQ16	16" window squeegee, red, economical	.12/ctn
SD318	18" non marking, zinc plated, red or gray	.6/ctn
SD324	24" non marking, zinc plated, red or gray	.6/ctn
SD330	30" non marking, zinc plated, red or gray	.6/ctn
SD336	36" non marking, zinc plated, red or gray	.6/ctn
SD348	48" non marking, zinc plated, red or gray	.6/ctn
SD318C	18" non marking, zinc plated, curved, red or gray	.6/ctn
SD324C	24" non marking, zinc plated, curved, red or gray	.6/ctn
SD330C	30" non marking, zinc plated, curved, red or gray	.6/ctn
SD336C	36" non marking, zinc plated, curved, red or gray	.6/ctn
MPF-15	15" aluminum channel, dual edge blade, red	.6/ctn
MPF-18	18" aluminum channel, dual edge blade, red	.6/ctn
MPF-24	24" aluminum channel, dual edge blade, red	.6/ctn
MPF-30	30" aluminum channel, dual edge blade, red	.6/ctn

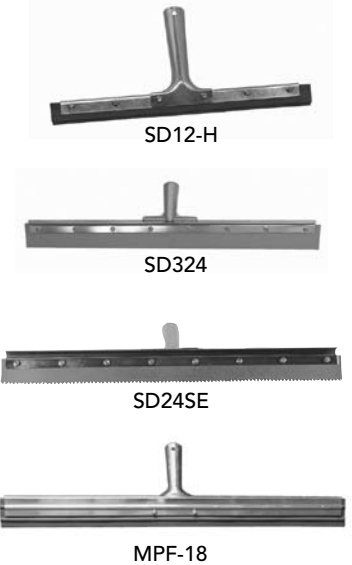

Serrated Edge

SD18SE	18" serrated edge, red or gray, 1/8", 3/16", 1/4", 3/8", 1/2"	.6/ctn
SD24SE	24" serrated edge, red or gray, 1/8", 3/16", 1/4", 3/8", 1/2"	.6/ctn
SD30SE	30" serrated edge, red or gray, 1/8", 3/16", 1/4", 3/8", 1/2"	.6/ctn
SD36SE	36" serrated edge, red or gray, 1/8", 3/16", 1/4", 3/8", 1/2"	.6/ctn
MPFSE-15	15" aluminum channel, reversible blade, 1/8", 3/16", 1/4"	.6/ctn
MPFSE-18	18" aluminum channel, reversible blade, 1/8", 3/16", 1/4"	.6/ctn
MPFSE-24	24" aluminum channel, reversible blade, 1/8", 3/16", 1/4"	.6/ctn
MPFSE-30	30" aluminum channel, reversible blade, 1/8", 3/16", 1/4"	.6/ctn
78000	16" application squeegee, reusable, THA	.1 ea
78101	24" application squeegee, reusable, THA	.1 ea



Crack Fillers

46002	Lighweight Crack filler squeegee	.1 ea
46001	Heavy-duty U-Crack filler squeegee	.1 ea
46005	Push/Pull V-Crack filler squeegee	.1 ea

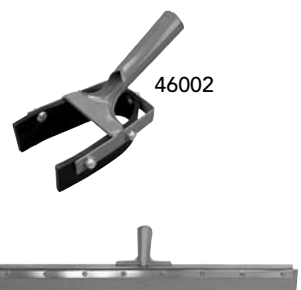

Sponge Blade Floor Squeegee

SD318-Sponge	18" double sponge squeegee	.4/ctn
SD324-Sponge	24" double sponge squeegee	.4/ctn
SD330-Sponge	30" double sponge squeegee	.4/ctn
SD336-Sponge	36" double sponge squeegee	.4/ctn
SD348-Sponge	48" double sponge squeegee	.4/ctn

**Refill Blades and Rolls available in flat, serrated,
EPDM, neoprene and sponge rubber.**



Products Guaranteed To Your Satisfaction!



FB218P



FB1618S

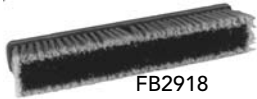

FB2918



A12



AB12



S-7914



5QT



FLOOR SWEEPS

Fine Sweeps

Fine synthetic center, horsehair and synthetic border, 3" trim. No matting or laying over of bristles. Our best fine sweep for smooth floors.

FB218P	18"	1ea
FB224P	24"	1ea
FB230P	30"	1ea
FB236P	36"	1ea

Coarse Sweeps

Stiff synthetic fill, 3" trim for all coarse or outside sweeping. No matting or laying over of bristles. Our best course sweep.

FB1618S	18"	1ea
FB1624S	24"	1ea
FB1630S	30"	1ea
FB1636S	36"	1ea

All Purpose Sweeps

Medium stiff synthetic center, flagged synthetic border, 3" trim. All purpose brush sweeps fine dust yet will sweep heavy debris effectively. No matting or curling.

FB2918	18"	1ea	FB2930	30"	1ea
FB2924	24"	1ea	FB2936	36"	1ea

APPLICATOR PADS & BLOCKS

Genuine super quality 100% lambswool. All have 3/4" nap.

A12	12" lambswool pad	1 ea
A16	16" lambswool pad	1 ea
A18	18" lambswool pad	1 ea
AB12	12" block and lambswool pad	1 ea
AB16	16" block and lambswool pad	1 ea
AB18	18" block and lambswool pad	1 ea

PAILS

S-9942	3.5 gallon plastic pail, lid not included	.50 ea
S-7914	5 gallon plastic pail, lid not included	.1 ea
S-11862	6 gallon plastic pail, lid not included	.50 ea
S-9948	Lid for 9942,7914,11862	.5 ea
S-9943	Lid, 5 gallon pail, with Sprout	.50 ea
S-9941	2 gallon plastic pail, lid not included	.50 ea
S-9947	Lid, 2 gallon, plastic	.1 ea
S-7344	5 Gallon steel pail	.5/ctn
5 QT	5 quart clear multi-mix container, qt & liter	.50/ctn
5 QT-H	5 quart multi-mix container, with handle, qt & liter	.24/ctn
10 QT-H	10 quart multi-mix container, with handle, qt & liter	.12/ctn
2.5 QT	2-1/2 quart multi-mix container, qt & liter	.100/ctn
1QT	1 quart multi-mix container, qt & liter	.300/ctn

CHIP BRUSHES

White China Bristle (Plain Sanded Handle) These stay in one piece while using.

	Width	Thickness	Trim	Std. Pack	Master Case
PB1/2	1/2	1/4	1-1/2	36/ctn	864/case
PB1	1	5/16	1-1/2	36/ctn	864/case
PB1-1/2	1-1/2	5/16	1-1/2	36/ctn	864/case
PB2	2	5/16	1-1/2	36/ctn	864/case
PB3	3	3/8	1-1/2	12/ctn	432/case
PB4	4	3/8	2	12/ctn	288/case
PB4HD	4	11/16	2	12/ctn	144/case

GLOVES

FAX: 940-484-5287

Cotton Gloves

7009 brown jersey, knit wrist dz
7109 natural colored jersey, knit wrist, dz
8008 white cotton canvas, knit wrist, 8 oz. dz

Cotton Gloves - String Knit

9500 natural, polyester/cotton dz
9601 string knit, PVC dots on one side dz
9600 string knit, PVC dots on two sides dz
9800 string knit, dipped, coated string dz

Chemical Resistant - Unsupported

4060XL latex, 5.5 mil, disposable glove, 100/ctn 1ea
4090XL nitrile, 4 mil, disposable glove, 100/ctn 1ea
4210N cannery natural unlined latex, 17 mil dz
4511 nitrile, flock lined, size 11 dz
5010 19 mil, 12" yellow latex dz
5110 19 mil, 12" blue flock lined latex dz
5210 17 mil, 12" unlined "Cannery" latex dz
5511 15 mil, 13" nitrile, flock lining dz
5710 19 mil, 12" black neoprene dz
5807 28 mil, blue neoprene over yellow latex dz



KNEE PADS

20010 ultralight knee pad, flexible, non skid outer shell 1 ea
20030 ultralight knee pad w/hard caps 1 ea
71221 journeyman pro knee pad 1 ea
71251 journeyman rubber knee pad, velcro fasteners 1 ea
20060 megalight knee pad, molded close cell foam 1 ea
71205 kneepro ultra flex, hinged hard plastic outer shell 1 ea
7102 MaxKnee with plastic cap 1 ea
7103 FlexKnee with rubber cap 1 ea



TAPE

NSH-395 2" x 60 yds, duct tape, general grade, 9 mil, Nashua24/ctn
BT-287R 2" x 60 yds, duct tape, general grade, 9 mil, Red, Bron24/ctn
PC-590 2" x 60 yds, duct tape, utility grade, 9 mil24/ctn
PC-595 2" x 60 yds, duct tape, utility grade, 9.3 mil24/ctn
2280 2" x 60 yds duct tape, general grade, Bron24/ctn
ST-261 2" x 60 yds duct tape, general grade24/ctn
ST-264 2" x 60 yds duct tape, medium grade, 10 mil24/ctn
BT-287-2 2" x 60 yds, duct tape, medium grade, 9 mil, Bron24/ctn
BT-287-3 3" x 60 yds, duct tape, medium grade, 9 mil, Bron24/ctn
PC-609 2" x 60 yds duct tape, premium grade24/ctn
ST-10 2" x 60 yds, masking tape, utility grade24/ctn
ST-9 2" x 60 yds, masking tape, medium grade24/ctn
ST-4 2" x 60 yds, masking tape, premium grade24/ctn
CP-27 2" x 60 yds, Blue UV masking tape24/ctn
BT-290 2" x 60 yds, Blue UV masking tape, Bron24/ctn
BT-290-1 1" x 60 yds, Blue UV masking tape, Bron36/ctn
BT-133 2" x 60 yd, Red Poly tape, Bron24/ctn
BT-18-80 stretch wrap, 18" x 1500, 80 ga, Bron4/ctn
BT-44880 masking film, 48" x 180', Bron12/ctn
KRAFT Kraft red rosin paper, 36" x 160'1/ctn



Tape

Products Guaranteed To Your Satisfaction!



BARRICADE TAPE

BT-49	Danger Danger Danger, Tape, 3" x 1000 lf	10/ctn
BT-5	Caution Caution Caution, Tape, 3" x 1000 lf	10/ctn
BT-8	Caution Do Not Enter, Tape, 3" x 1000 lf	10/ctn
BT-66	Caution Cuidado, Tape, 3" x 1000 lf	10/ctn
BT-23	Caution Men Working, Tape, 3" x 1000 lf	10/ctn
BT-275	Caution Authorized Personnel Only, Tape, 3" x 1000 lf	10/ctn
BT-20	Wet Paint, Tape, 3" x 1000 lf	10/ctn
BT-290	Caution Wet Paint, Tape, 3" x 1000 lf	10/ctn
BT-284	Hazardous Area Keep Out, Tape, 3" x 1000 lf	10/ctn

EXTENSION CORDS

C4314-100	14/3, 100 lf, extension cord, Unlighted	4/ctn
C4314-50	14/3, 50 lf, extension cord, Unlighted	8/ctn
C4312-100-YW	12/3, 100 lf, yellow, extension cord, Unlighted	4/ctn
C4312-050-YW	12/3, 50 lf, yellow, extension cord, Unlighted	8/ctn
CL2312-100	12/3, 100 lf, extension cord, Lighted	3/ctn
CL2312-50	12/3, 50 lf, extension cord, Lighted	5/ctn
C600835	12/3, 100 lf, extension cord, Triple Tap	3/ctn
C600830	12/3, 50 lf, extension cord, Triple Tap	5/ctn
LT511935	10/3, 100 lf, yellow, extension cord, Lighted	4/ctn
LT511930	10/3, 50 lf, yellow, extension cord, Lighted	8/ctn
320803	36" in-line switch GFCI, Triple Tap, Lighted	8/ctn

PORTABLE LIGHTING

O7776	Dual head portable floodlight, 1000W, 4'-6-1/2'	2/ctn
O7777	Single head portable floodlight, 500W	2/ctn
O7775	Hand-held portable floodlight, 500W	6/ctn

FANS

9230	30" Floor fan, 3 speed, 60 Hz, rear mounted controls	1 ea
9224	24" Floor fan, 3 speed, 60 Hz, rear mounted controls	1 ea
9942	42" Belt drive drum fan, 2 speed, 60 Hz, 1/2 hp motor	1 ea
9936	36" Belt drive drum fan, 2 speed, 60 Hz, 1/2 hp motor	1 ea
9236	36" Direct drive drum fan, 2 speed, 60 Hz, 1/3 hp motor	1 ea

DIAMOND TOOLS

Cup Wheels & Blades

PGCS-4	4" premium grade, single row cup wheel	1 ea
PGCS-7	7" premium grade, single row cup wheel	1 ea
PGCD-4	4" premium grade, double row cup wheel	1 ea
PGCD-7	7" premium grade, double row cup wheel	1 ea
STP10-4	4", 10 segment, turbo cup wheel	1 ea
STP18-4	4", 18 segment, turbo cup wheel	1 ea
STP18-4.5	4.5", 18 segment, turbo cup wheel	1 ea
STP12-7	7", 12 segment, turbo cup wheel	1 ea
STP24-7	7", 24 segment, turbo cup wheel	1 ea
CTW-4	4", coarse, turbo cup wheel	1 ea
CTW-4.5	4-1/2", coarse, turbo cup wheel	1 ea



C4312-050

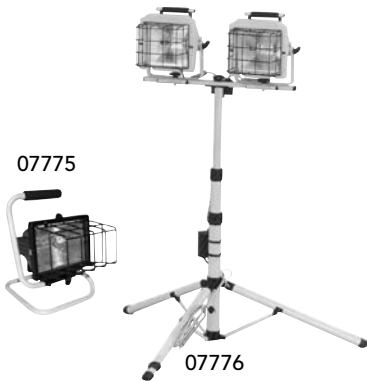

O7776

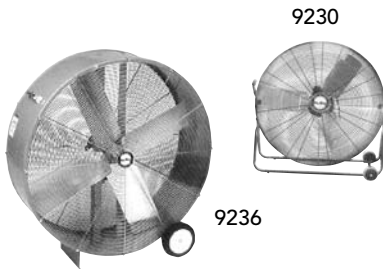

9230



CTW-5	5", coarse, turbo cup wheel	1 ea
CTW-7	7", coarse, turbo cup wheel	1 ea
TSEG-7	7", T-Segment, turbo cup wheel	1 ea
CRBP-4	4", continuous rim blade, premium	1 ea
CRBP-4.5	4.5", continuous rim blade, premium	1 ea
CRBP-7	7", coarse, continuous rim blade, premium	1 ea
TRBP-4	4", turbo rim blade, premium	1 ea
TRBP-4.5	4.5" turbo rim blade, premium	1 ea
TRBP-5	5", turbo rim blade, premium	1 ea
TRBP-7	7", turbo rim blade, premium	1 ea
TRBP-8	8", turbo rim blade, premium	1h



TSEG-7

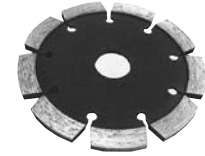

Tuck Point

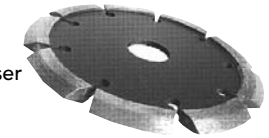

Crack Chaser

TUCK POINT

7TP500	7", tuck point blade, .500	1 ea
4TP250	4", tuck point blade, .250	1 ea
4.5TP250	4.5", tuck point blade, .250	1 ea
5TP250	5", tuck point blade, .250	1 ea
7TP250	7" tuck point blade, .250	1 ea
8TP250	8" tuck point blade, .250	1 ea

CRACK CHASERS

SCV-4	4" X .250", V-shape crack chaser, 5/8"	1 ea
SCV-5	4.5" X .250", V-shape crack chaser, 5/8"	1 ea
SCV-7	7" X .250", V-shape crack chaser, 5/8"	1 ea
SCV-7.3	7" x .375", V-Shape crack chaser, 5/8"	1 ea
SCV-8	8" x .375", V-Shape crack chaser, 5/8"	1 ea

FLOOR MAGNETS

MKS100	12" broom magnet	1 ea
MK185	15" indoor sweeper magnet, 3" tall	1 ea
MKUSM	36" utility floor magnet sweeper	1 ea
AUTO 24	24" delue auto magnet sweeper	1 ea
AUTO 36	36" delue auto magnet sweeper	1 ea
MK24ST	20" self-cleaning sweep, 5" wheels	1 ea
MKS1-24	24" heavy-duty sweep, self-cleaning, 10" wheels	1 ea
MKS1-36	36" heavy-duty sweep, self-cleaning, 10" wheels	1 ea



MK24ST

MKS1-24

FLOOR TOOLS

62902	4" razor scraper, 18" handle, economy	1 ea
72708	4" razor scraper, 18" handle, heavy-duty	1 ea
62911	4" adjustable scraper, 24" to 41"	1 ea
62901	4" replacement blades, 100/ctn	1 ea
72714	4" razor scraper, 48" handle	1 ea
62590	5" heavy-duty razor scraper, 18" handle	1 ea
62591	5" heavy-duty razor scraper, 48" handle	1 ea
62599	5" heavy-duty replacement blades, 50/ctn	1 ea
72762	8" adjustable scraper, 39" - 59"	1 ea
72765	8" replacement blades for 72762, 9/ctn	1 ea
20900	5' pro floor scraper with 14" blade	1 ea
21000	14" replacement blade for 20900, 3/ctn	1 ea
75006	4' heavy-duty floor scraper, 3/4" handle, 7" blade	1 ea
75007	7" replacement blade for 75006	1 ea
78908	8" stainless steel blade scraper, w/66" alum handle	1 ea
78912	12" stainless steel blade scraper, w/66" alum handle	1 ea
78916	16" stainless steel blade scraper, w/66" alum handle	1 ea

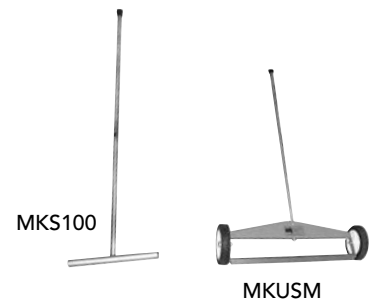

MKS100

MKUSM



62902

20900

75006

78912

Products Guaranteed To Your Satisfaction!

FLOOR SANDING PRODUCTS

SANDING DISCS

Sizes available: 15", 16", 17", 18", 19" and 20"
 Grit sizes: 120, 100, 80, 60, 50, 40, 36, 30, 24, 20, 16, 12

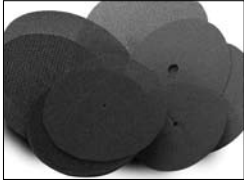

SCREEN DISCS

Sizes available: 15", 16", 17", 18", 19" and 20"
 Grit sizes: 150, 120, 100, 80, 60

SPIKED SANDALS

- 12-844-1 spiked sandals - plastic, 3/4" spikes1 ea
- 46104 steel spiked shoes, 1", hinged1 ea
- 46125 3/4" replacement spikes for 12-844-1, set of 261 ea
- 46126 1" replacement spikes for 12-844-1, set of 261 ea
- 46127 1-1/2" replacement spikes for 12-844-1, set of 261 ea

PLASTIC TERMINATION STRIPS

- 2837-C Premolded strip, 1/8" x 1/2", w or w/o tape, Clear 1000 lf
- 2837-RD Premolded strip, 1/8" x 1/2", Red, Tape 1000 lf
- 2837-GR Premolded strip, 1/8" x 1/2", Green, Tape 1000 lf
- 2837-WT Premolded strip, 1/8" x 1/2", White, Tape 1000 lf
- 2837-BL Premolded strip, 1/8" x 1/2", Blue, Tape 1000 lf
- 2837-BK Premolded strip, 1/8" x 1/2", Black, Tape 1000 lf
- 2837-GY Premolded strip, 1/8" x 1/2", Gray, Tape 1000 lf
- 4498 Premolded strip, 1/8" x 1/2", 45° angle, White, Tape 1000 lf
- 4445 Premolded floor strip, 1/4" x 1/2", Gray, w/o tape 500 lf
- 4336 Premolded floor strip, 5/16" x 1/2", Clear, w/o tape 1000 lf
- 4612 Premolded control joint strip, 1/4" x 1/2", Clear, Tape 1000 lf
- 4332 Premolded control joint strip, 1/4" x 1-3/8", Clear, Tape 500 lf
- 4640 Premolded control joint strip, 3/16" x 1-3/8", Clear, Tape 500 lf
- 4680 Premolded strip, 1/16" x 1/2", Clear, w or w/o tape 1000 lf
- 12-473 Stainless steel cove trowel, 3/4" radius 1000 lf
- CF211C 3" x 12" Trowel, camel back handle 1000 lf
- Epoxy Cove Gel Gel consistency Cove Base Epoxy, UV stable 15 gal

See Back Cover for More Detail.

VAPOR TESTING

- VAP-12 anhydrous calcium chloride test kit, (12 per kit)1 ea
- TANITA-1479 electronic gram scale w/field calibration kit1 ea
- CRH Electronic meter - moisture & relative humidity1 ea
- CME 4 Electronic concrete meter, hand-held1 ea

GAUGE RAKES

- 57030 12" Cam floor topper, THA1 ea
- 57000 24" Cam floor topper, THA1 ea
- 57010 36" Cam floor topper, THA1 ea
- 57020 48" Cam floor topper, THA1 ea
- 57078 Cam size A - 1/32"1 ea
- 57079 Cam size B - 1/24"1 ea
- 57081-96 Cam - sizes - 1/16, 1/8, 3/16, 1/4, 5/16, 3/8, 1/2, 5/8", 1"1 ea
- 58714 14" Wire gauge rake, THA1 ea
- 58609 24" Wire gauge rake, THA1 ea
- 58734 36" Wire gauge rake, THA1 ea
- 68611 Replacement for Wire gauge rakes (set of 3)1 ea

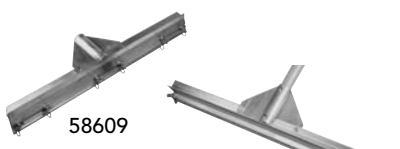

APPLICATION TOOLS

FAX: 940-484-5287

12-473	Stainless steel cove trowel, 3/4" radius	1 ea
CF211C	3" x 12" Trowel, camel back handle	1 ea
78900	24-1/2" x 3-1/4", straight blade smoother, THA	1 ea
78906	24" X 5", flexible blade smoother, round edge, THA	1 ea
78926	36" x 5", flexible blade smoother, round edge, THA	1 ea
47415	12" "Magic Trowel" smoother	1 ea
47416	18" "Magic Trowel" smoother	1 ea
46417	22" "Magic Trowel" smoother	1 ea
47418	24" "Magic Trowel" smoother	1 ea
47419	26" "Magic Trowel" smoother	1 ea
76250	15 gallon mixing barrel	1 ea
78708	Hand Held squeegee, 3" round edge blade	1 ea
78709	Hand Held squeegee, 1-1/2" square edge blade	1 ea
70108	9" aluminum roller, radial frame	1 ea
70109	9" aluminum roller, THA	1 ea
70118	18" aluminum roller, THA	1 ea
70124	24" aluminum roller, THA	1 ea
70136	36" aluminum roller, THA	1 ea
70201	24" stub-spiked double roller	1 ea
70211	24" double aluminum roller, THA	1 ea
70206	stub-spiked terrazzo edger, THA	1 ea



SPIKED ROLLERS

59009	9" spiked roller - 7/16" spikes, paint roller handle	1 ea
59209	9" spiked roller, 7/16", alum core, handle adapt.	1 ea
59218	18" spiked roller, 7/16", alum core, handle adapt.	1 ea
59224	24" spiked roller, 7/16", alum core, handle adapt.	1 ea
59236	36" spiked roller, 7/16" alum core, handle adapt	1 ea
59248	48" spiked roller, 7/16", alum core, handle adapt.	1 ea
59458	9" spiked roller - 9/16" spikes, paint roller handle	1 ea
59459	9" spiked roller, 9/16", alum core, handle adapt.	1 ea
59468	18" spiked roller, 9/16", alum core, handle adapt.	1 ea
59474	24" spiked roller, 9/16", alum core, handle adapt.	1 ea
59486	36" spiked roller, 9/16" alum core, handle adapt	1 ea
59498	48" spiked roller, 9/16", alum core, handle adapt.	1 ea
59109	9" spiked roller - 13/16" spikes, paint roller handle	1 ea
59309	9" spiked roller, 13/16", alum core, handle adapt.	1 ea
59318	18" spiked roller, 13/16", alum core, handle adapt.	1 ea
59324	24" spiked roller, 13/16", alum core, handle adapt.	1 ea
59336	36" spiked roller, 13/16" alum core, handle adapt	1 ea
59348	48" spiked roller, 13/16", alum core, handle adapt.	1 ea



Replacement Roller

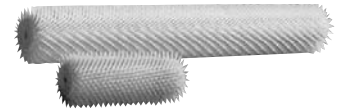

Porcupine Roller Covers

PORCUPINE ROLLER COVERS

RC9-PORC	9" porcupine roller - steel pins	1 ea
RC18-PORC	18" porcupine roller - steel pins	1 ea

FLOOR MACHINES

Powr-Flite		
P131	13" dia, 175 rpm, 1/3hp, single planetary transmission	1 ea
M171	17" dia, 175 rpm, 1 hp, dual planetary transmission	1 ea
M201	20" dia, 175 rpm, 1 hp, dual planetary transmission	1 ea
M171HD	17" dia, 175 rpm, 1.5 hp dual planetary transmission	1 ea
M171SD	17" dia, 175 rpm, 1.5 hp, dual planetary transmission	1 ea
M201HD	20" dia, 175 rpm, 1.5 hp, dual planetary transmission	1 ea



C171HD

Products Guaranteed To Your Satisfaction!



Floor Pads

M172	17" dia, 175 or 320 rpm dual speed, 1.5 hp triple trans1 ea
M202	20" dia, 175 or 320 rpm dual speed, 1.5 hp triple trans1 ea
C171	17" Classic, 175 rpm, 1hp1 ea
C171HD	17" Classic, 175 rpm, 1.5 hp1 ea
C171SD-3	17" Classic, 175 rpm, 1/5 hp, sandpaper block1 ea
C201	20" Classic, 175 rpm, 1hp1 ea
C201HD	20" Classic, 175 rpm, 1.5 hp1 ea

Floor Machine Pads

200313	13" in Black - Blue - Green - Red - White5/case
200414	14" in Black - Blue - Green - Red - White5/case
200515	15" in Black - Blue - Green - Red - White5/case
200616	16" in Black - Blue - Green - Red - White5/case
200717	17" in Black - Blue - Green - Red - White5/case
200818	18" in Black - Blue - Green - Red - White5/case
200919	19" in Black - Blue - Green - Red - White5/case
202020	20" in Black - Blue - Green - Red - White5/case
202121	21" in Black - Blue - Green - Red - White5/case
202222	22" in Black - Blue - Green - Red - White5/case



CS 34K



WNS 2220



16003



F 1509 FR



EBS 125



LD 1509



DustBuddie



DustHoodie



Dust Muzzle

DUST COLLECTION

Vacuums

CS 34 K	Unitec - Vacuum/Dust Extractor, wet or dry, 1 tool1 ea
CS 34 K/MAX	Unitec - Vacuum/Dust Extractor, wet or dry, 2 tools1 ea
252.222	Unitec - CS 34 K Filter bags, 5/ctn1 ea
WNS 1000	Ruwac, Baby Red, 32" x 20" x 35", 112 cfm, 9 gal pan1 ea
WNS 2220	Ruwac, Little Red, 32" x 20" x 35", 200 cfm, 2 motors1 ea
WS 2220	Ruwac, Quiet Raider, 32" x 20" x 51", 280 cfm, silencer1 ea
WS 2320	Ruwac, Red Raider, 32" x 20" x 51", 280 cfm1 ea
5060	Ruwac - 20" floor toll w/rollers & squeegee1 ea
5018	Ruwac - 32" floor sweep assembly1 ea
16003	16 Gal Dustless WD - 12' x 1-1/2" Hose1ea

Dust Collection Tools

F 1509 FR	Tuck Pointing machine, 11 amps1 ea
EBS 125	5" concrete grinder, with removable dust guard1 ea
LD 1509 FR	5" concrete grinder, 11 amp, 10,000 rpm1 ea
L 1106 VE	4-1/2" angle grinder, var speed, 5.5 amp, 2000-6500 rpm1 ea
L 1109 S	4-1/2" angle grinder, var speed, 6.6 amp, 10,000 rpm1 ea
L 1506 VV	4-1/2" angle grinder, 2/dust extraction, 110amp1 ea
L 1506 VR	5" angle grinder, 2/feedback motor, 11 amp1 ea
D1835	Dust Buddie shroud 5" UA & 18" hose1 ea
D1850	Dust Buddie shroud 7" UA & 18" hose1 ea
D1860	Dust Hoodie shroud 8" UA1 ea
D5160	6' DM hose1 ea
D5155	18" DM hose1 ea
SA1833	Dust Muzzle shroud 5", 2 pack1 ea
SA1845	Dust Muzzle shroud 7", 2 pack1 ea
SA1832.2	5" Universal adaptor1 ea
SA1843.2	7-8" Universal adaptor1ea

EQUIPMENT

FAX: 940-484-5287

Grinders

Single-Disc Grinder
Electric, 1.5hp
Dual-Disc Grinder
Electric, 1.5hp, 3hp or 5.5hp
Gasoline, 5.5hp or 11 hp
Propane, 11 hp
Four-Disc Grinder
Electric, 5hp, 11hp

Scarifiers

4" push model, gasoline, 5.5hp
8" push model, electric, 5 hp,
Gasoline, 5 hp
10" push model, electric, 7.5hp
Gasoline, 13hp
10" self-propelled, gasoline, 13hp, 20hp
8.5" Self-propelled, gasoline, 20hp
12" self-propelled, gasoline, 35hp

Traffic Line Remover TRL-7 Gasoline, 7" width, 9 or 11hp, (Honda) 1 ea
DYMA-SERTS Dyma-Serts, diamond segment backing plate 1 ea
Cutters Tungsten, Carbide, and steel cutters for all models 1 ea
K7-1 Aurand, 5" wide, 115 v, 1/8 hp, 9 lbs, scarifier 1 ea
K7-2 Aurand, 5" wide, 230 v, 1/8 hp, 9 lbs, scarifier 1 ea
K7-1E Aurand, 8" wide, 115 v, 1/8 hp, 11 lbs, scarifier 1 ea
K72E Aurand, 8" wide, 230 v, 1/8 hp, 11 lbs, scarifier 1 ea
M5-1 Aurand, 8" wide, 115 v, 1/2 hp, 21 lbs, scarifier 1 ea
M5-2 Aurand, 8" wide, 230 v, 1/2 hp, 21 lbs, scarifier 1 ea
MP6E Aurand, 12" wide, air, 2-1/2 hp, 24 lbs, scarifier 1 ea
W1G Aurand, 4-3/4" wide, gas, 5 hp, 90 lbs, line scarifier 1 ea
W1E Aurand, 4-3/4" wide, 115 v, 2 hp, 97 lbs, line scarifier 1 ea
W1E-V Aurand, 4-3/4" wide, 230 v, 2 hp, 115 lbs, line scarifier 1 ea



Single Disc
Grinder

Scarifier 12"

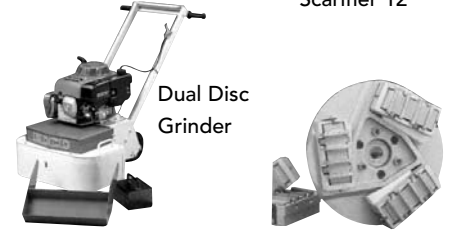

Dual Disc
Grinder

DYMA-SERTS

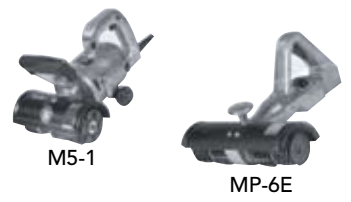

M5-1

MP-6E

POWER TROWELS

T304-VS power trowel, 30" electric, variable speed, 230V 1 ea
T364-VS power trowel, 36" electric, variable speed, 230V 1 ea
T304-RS power trowel, 30" gas, reduced speed, Honda, 5.5 hp 1 ea
T364-RS power trowel, 36" gas, reduced speed, Honda, 5.5 hp. 1 ea
T244E-RS 24" power trowel, electric, 1-1/2hp, 115/230V 1 ea
T304E-RS 30" power trowel, electric, 1-1/2hp, 115/230V 1 ea
T364E-RS 36" power trowel, electric, 2 hp, 234V. 1 ea
EX36-5.5 Superior, 36" gas, 5.5 hp, 25-65 rpm 1 ea
EX36-E Superior, 36", electric, 2 hp, 5-65 rpm 110 or 220 volt 1 ea
PROPANE KIT Superior, Propane kit 1 ea
6.5-36-4 Boren epoxy power trowel, 19-210 rpm, 6.5 hp, 4 blade 1 ea
6.5-36-5 Boren epoxy power trowel, 19-210 rpm, 6.5 hp, 5 blade 1 ea

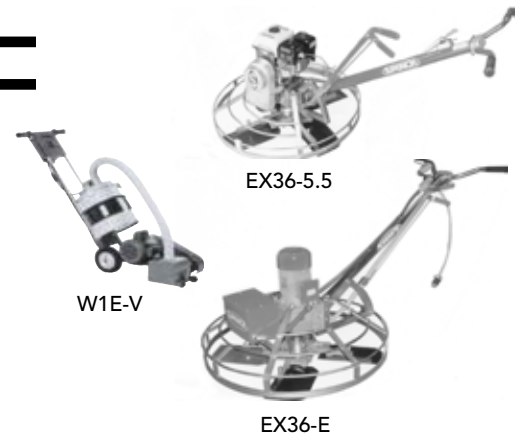

W1E-V

EX36-5.5

EX36-E

BATCH MIXERS

EMM Epoxy mortar mixer, 125 lb, large capacity, 110 power 1 ea
TBF5GBM Epoxy mortar mixer, 5 gal Bucket Mixer 1 ea
M61 KOL, epoxy mortar mixer, 10 gal, 1/2 hp, 30 or 60 rpm 1 ea
M61-Mobile KOL, epoxy mortar mixer, mobile, 10 gal, 30 or 60 rpm 1 ea
MS45E Stow, Mortar Mixer, 4.5 cu ft, elec, 110/230 v 1 ea
MS45G Stow, Mortar Mixer, 4.5 cu ft, gas, 5.5 hp 1 ea

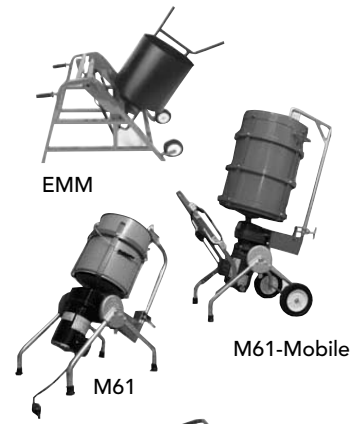

EMM

M61

M61-Mobile

SCREED BOXES/TOTER

ESB-24 24" epoxy screed box 1 ea
ESB-36 36" epoxy screed box 1 ea
90300 30" screed box, 1.9 cu/ft capacity 1 ea
90400 36" screed box, 2.2 cu/ft capacity 1 ea
ET Epoxy toter, 125 lb, large capacity, use with EMM 1 ea



ESB-24

ET

Products Guaranteed To Your Satisfaction!

MIXERS

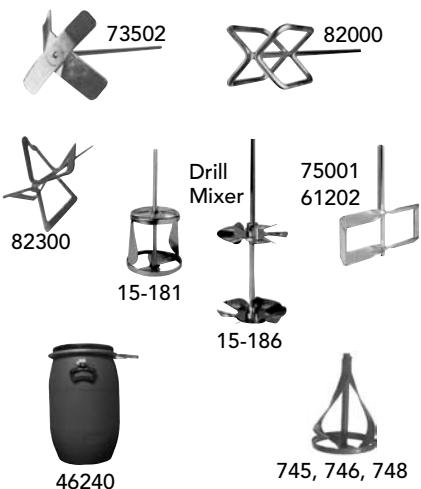

- 75001 8-1/2" x 24" length, thinset mixer1 ea
- 61202 8-1/2" x 36" length, thinset mixer1 ea
- 15-170 8" X 4-1/2" X 28" , thinset mixer1 ea
- 73502 cross-blade mixer, 5" blade, 28" shaft1 ea
- 15-181 Resin Mixer, 5" dia, 1/2" x 20-1/2"1 ea
- 15-186 Drill Mixer, 3/8" x 24" double, 5" wheel1 ea
- 82000 kwikmixer, 30" shaft, mortar mixer.1 ea
- 82300 ez-mixer, 30" shaft, mortar mixer1 ea
- 745 power mixer, 4-3/4" x 30" shaft1 ea
- 746 power mixer, 4" x 23-1/2" shaft1 ea
- 748 power mixer, 2-3/8" x 17" shaft1 ea
- 46240 15 gallon mixing barrel1 ea

SAFETY

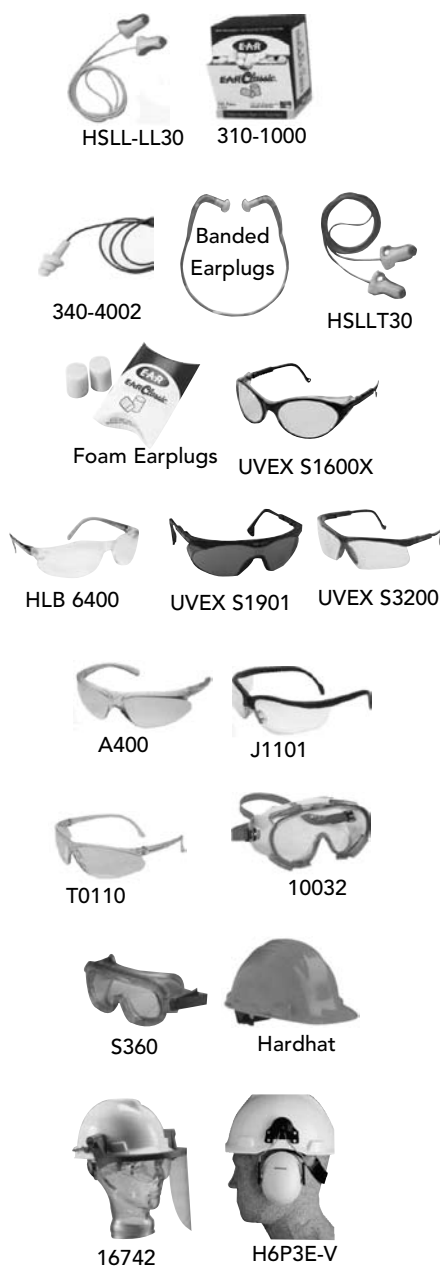

- QB2HYG. earplugs, banded supra aural style, fits inside ear10/box
- QB3HYG. earplugs, banded semi-aural style, fits to ear.10/box
- HSLLT30 earplugs, laser-trak, disposable earplug100/box
- HSLLL-30 earplugs, laser-lite, disposable earplug100/box
- 310-1001 earplugs, ear classic, foam disposable earplug200/box
- 340-4002 E-A-R earplugs, triple-flange, poly cord, yellow.50/box
- 340-4004 E-A-R earplugs, stem design, corded, yellow.100/box
- 318-1001 earplugs, stem design, corded100/box
- MOL6650 earplug, softie w/cord.100/box
- HLB 6400 safety glasses, Mako,wrap around, clear or gray12/box
- HLB 6400-2. safety glasses, Mako,wrap around, gray12/box
- 67MB safety glasses, Rage, spring hinges, bayonet temples12/box
- UVEX S1600X. safety glasses, Bandit, wrap around, clear, black frame.12/box
- UVEX S3200 safety glasses, Genesis, sports style wrap around, clear12/box
- UVEX S3100 safety glasses, U2, sporty frame w/adjustalbe temples12/box
- UVEX S1901 safety glasses, Skyper, wrap around, molded browguard12/box
- UVEX A400. safety glasses, Spartan, wrap around12/box
- UVEX S2814. safety glasses, Scyper X2, mirror, black frame12/box
- J1101 safety glasses, Journey, gel nosepiece.12/box
- T0110 safety glasses, Titan, ultra lightweight, sporty12/box
- CLST120. safety glasses, Storm ratchet temples12/box
- SW152 safety glasses, Smith & Wesson, blkd frm, smoke1 ea
- 2220R goggles, rubber strap, perforated1 ea
- 10032 Monogoggle, indirect ventilation1 ea
- UVEX S360 goggle, indirect vents, anti-fog coating1 ea
- 475363 MSA V-Gard hard hat, fast trac suspension1 ea
- 463942 Hard hat, fas-trac suspension1 ea
- 16742 foldback faceshield frame, cap style, dielectric1 ea
- 488138 clear, polycarbonate visor.1 ea
- 21614 MSA, faceshield frame, lightweight polypropylene1 ea
- 5383 MSA, hat foldback faceshield frame.1 ea
- H6P3E-V. hardhat mounted hearing protectors1/box
- 330-3001 three position earmuffs.1/box
- 1010926 Viking V2 Noise blocking earmuff 25 NRR1 ea
- 1010924 Leightning noise blocking earmuff1 ea
- H7A461 Peltor powercom communications headset1 ea
- 3M 8000. N95 Particulate respirator, economy30/box
- 3M 8210. N95 Particulate respirator.20/box

3M 8511	N95 Particulate respirator, w/cool flow valve	20/box
3M 9210	N95 Particulate respirator, 3 panel design	20/box
3M 9211	N95 Particulate respirator, 3 panel w/cool flow valve	20/box
3M 8247	R95 Particulate respirator, nuisance level organic vapor	20/box
3M 6200	half facepiece respirator, low maint, 3 sizes	1 ea
3M 6800	full facepiece respirator, low maint, 3 sizes	1 ea
3M 7502	3M half facepiece, cool flow exhalation valve, 3 sizes	1 ea
3M 7800	3M full facepiece, low profile, six pont head strap	1 ea
3M 5301	3M half facepiece, attached cartridge, OV respirator	1 ea
3M 52P71	3M half facepiece, OV respirator	1 ea
NOR 54001	North full facepiece, oral/nasal cup reduces fogging	1 ea
BA 2430	3M Air-Mate SCBA, combo escape and supplied air	1 ea
NOR 832	SCBA respirator, 30 minute cylinder	1 ea
3M L-501	3M supplied air helmet	1 ea
3M 6006	multi gas/vapor cartridge, 2/pack	pack
3M 2091	P100 particulate filter, 2/pack	pack
3M 502	3M HEPA filter adapter for 6000 series, 2/pack	pack
NOR 75SC	Defender multi purpose cartridge, 2/pack	pack
NOR 775FFP	P100 particulate filter	1 ea
NOR 750035	Adapter for pancake filter, N75FFP	1 ea
KID 466112	Kidde, 5 lb, ABC dry-chemical fire extinguisher	1 ea
KID 466204	Kidde, 10 lb, ABC dry-chemical fire extinguisher	1 ea
FAO 222-U	10-person bulk first aid kit	1 ea
FAO 223-G	25-person bulk first aid kit	1 ea
FAO 239	16-person ANSI fill, plastic box	1 ea
FAO 245	first aid station, metal cabinet, 2 shelf w/swing door	1 ea
FAO 248	first aid station, metal cabinet, 4 shelf, 20 pocket liner	1 ea
127035	16 OZ, Double eyewash station	1 ea
127032	32 OZ, Single eyewash station	1 ea
126037	32 OZ, eye and skin flush refill	1 ea
GAMIC	Multi-gas detctor, LCD display	1 ea
3M 3500	Air monitoring badges for organic vapor	case
DTEC 03432	Back support beld, moderate lifting, suspenders	1 ea
OK-5 BKSL	Heavy lifting belt, rigid inner core, built-in lumbar pad	1 ea
OK-2000	Average lifting belt, coutour fit	1 ea
OK-AMBI	Wrist support, ambidextrous	1 ea
OK-NCTS	Wrist support, left or right hand	1 ea
FLA 71-41	Wrist support, Safe-T-Wrist, universal	1 ea
DZM 950	Miller Python harness, interwoven webbing	1 ea
1102000	full body harness, vest style, universal size	1 ea
7010A	Protecta, Compliance in a can, full body harness	1 ea
DZM 50GCN	50' MightEvac rescue SRL, tripod, 60' winch	1 ea
DTEC 1100	Tyvek shoe covers, elastic top, 100/ case	200/cs
DTEC 1412	Tyvek coverall, S, M, L, XL	25/cs
DTEC 1417	Tyvek elastic coverall, S, M, L, XL	25/cs
DTEC 1428	Tyvek hooded coverall, S, M, L, XL	25/cs
DTEC 1550	Tyvek pants, elastic waist, S, M, L, XL	50/cs
DTEC 1218	Tyvek elastic sleeves, 18"	100/cs
18821-12	16" multi-compound black knee boot, economy	1 pr
73505	15" knee boot, steel toe, cleat sole and heal	1 pr
WL300	winter liner, 100% cotton w/fleece lining	1 ea
WL400	winter liner, 100% cotton, w/shepva lining	1 ea



7A461



3M 8210



330-3001



3M 6200



NOR 54001



3M 6800



3M 9211



Cartridges



Kiddie Fire Extinguisher



NOR 832



FAO 222-U



DTEC03432



GAMIC



1102000



127032



OK-5BKSL



OK-AMBI



DZM-50GCN



7010A



DTEC 1428



73505



WL300

Many more Safety Products available.



Premolded plastic termination strips are used in conjunction with hand troweled or self-leveling resinous flooring systems. The PTS strips are adhered horizontally to the wall surface to form a controlled edge for the placement of the formed cove or glued to horizontal substrates for controlled termination of the flooring systems.

ADVANTAGES

- ✓ Ease of application
- ✓ Flexible plastic allows quick on-site application
- ✓ Available with or without self-adhering tape
- ✓ Controls height and thickness of edge

SIMPLE INSTRUCTIONS

- ✓ Apply to clean and sound surface
- ✓ Remove protective strip from tape and adhere PTS strip at required height or glue with appropriate adhesive
- ✓ Cut strips to length with ordinary jobsite tools
- ✓ Snip top edge in a "V" to allow strip to bend for outside or inside corners



COMPONENTS: All of the PTS strips are available in Clear and 6 standard colors (Gray, Red, Blue, White, Black and Green). Other colors are available upon request. PTS strips are manufactured in 5' lengths. Other shapes and configurations are available upon request.

Quality Products Guaranteed To Your Satisfaction!

KEP, INC./REPUBLIC SUPPLIES, d.b.a.

2229 Pembroke Place, Denton, TX 76205

Phone: 800.713.7157 Fax: 940.484.5287

email: kp@republicsupplies.net

www.republicsupplies.net

